

# OPERATION **MANUAL**

**CLASSIC PLUS 14 and CLASSIC PLUS 26**



**READ THIS MANUAL CAREFULLY FOR INSTRUCTIONS ON CORRECT  
INSTALLATION AND USAGE AND READ ALL SAFEGUARDS**

SECCIÒN EN ESPAÑOL  
SECTION EN FRANÇAIS  
AVAILABLE AT [WWW.MOVINCOOL.COM](http://WWW.MOVINCOOL.COM)



**MOVINCOOL®**  
THE #1 SPOT COOLING SOLUTION

© 2007 DENSO SALES CALIFORNIA , INC.

All rights reserved. This book may not be reproduced or copied, in whole or in part, without the written permission of the publisher. DENSO SALES CALIFORNIA, INC. reserves the right to make changes without prior notice. MovinCool is a registered trademark of DENSO Corporation.

# OPERATION **MANUAL**

**CLASSIC PLUS 14 and CLASSIC PLUS 26**

# Table of Contents

<b>FOREWORD</b>	5
Definition of Terms	5
<b>GENERAL WARNINGS &amp; CAUTIONS</b>	6
<b>INVENTORY &amp; ASSEMBLY</b>	7
Inventory	7
Assembly	8
<b>INSTALLATION</b>	9
Choosing an Installation Site	9
Moving the Unit	10
Plugging in the Unit	11
LCDI Power Cord Instruction	12
<b>FEATURES</b>	13
<b>OPERATION</b>	14
Control Panel	14
LCD Indicators	15
Set Clock	16
Operating in COOL Mode	16
Operating in Fan Only Mode	16
Changing from Fan Only Mode to COOL Mode	16
How to Set a Program	17
How to View and Delete Program	18
How to Run and Stop Program	18
Operating Modes	19
Self-Diagnostic Codes	20
Empty the Drain Tank	21
Drain Pump Kit (Optional)	22
<b>DAILY INSPECTION &amp; MAINTENANCE</b>	24
Empty the Drain Tank	24
Clean the Air Filters	24
Filter Removal Method	24
Filter Element Cleaning Method	24
In-Season/Off-Season Inspection & Maintenance	25
<b>TROUBLESHOOTING</b>	26
<b>TECHNICAL SPECIFICATIONS</b>	27

# FOREWORD

Congratulations on purchasing the MovinCool portable air conditioner. This manual explains how to install and operate the MovinCool Classic Plus 14, and Classic Plus 26 portable air conditioning units. Please read this operation manual thoroughly to familiarize yourself with the features of the unit and to ensure years of reliable operation.

You may also find it useful to keep this operation manual on hand for reference. Components and/or procedures are subject to change without prior notice.

## Definition of Terms

 **WARNING:** Describes precautions that should be observed in order to prevent injury to the user during installation or unit operation.

 **CAUTION:** Describes precautions that should be observed in order to prevent damage to the unit or its components, which may occur during installation or unit operation if sufficient care is not taken.

*NOTE: Provides additional information that facilitates installation on unit operation.*

## **GENERAL WARNINGS & CAUTIONS**

- 1) All electrical work, if necessary, should only be performed by qualified electrical personnel. Repair to electrical components by non-certified technicians may result in personal injury and/or damage to the unit. All electrical components replaced must be genuine MovinCool parts, purchased from an authorized reseller.**
- 2) The proper electrical outlet for MovinCool units must be equipped with a UL approved circuit breaker.**
- 3) Because of potential safety hazards under a certain condition, we strongly recommend against the use of an extension cord. However, if you still elect to use an extension cord, it is absolutely necessary that it will be a UL listed, 3-wire grounding type appliance extension cord, having a 3-blade grounding plug and a 3-slot receptacle that will plug into the appliance. The marked rating of the extension cord should be 115 V, 15A for Classic Plus 14, and 230V, 20A for Classic Plus 26 or equivalent.**
- 4) The Classic Plus 14 is equipped with a ten (10) foot (3 meter) UL approved LCDI power cords. The Classic Plus 26 is equipped with a six (6) foot (1.8 meter) UL approved LCDI power cord. If replacement, fixed location (hard wired) or power cord lengthening (extension cord) cords are required, contact your reseller or a qualified electrician for approved replacement methods.**
- 5) Never fold or place heavy objects on the power cord. This could result in damage to the power cord causing electrical shock or fire.**
- 6) Do not place water or any other liquid on the unit. This can cause damage to the unit and increase the risk of electrical shock.**
- 7) Do not sit or stand on the unit.**

# INVENTORY & ASSEMBLY

## Inventory

After unpacking your MovinCool unit, please check to make sure you have the following items:

- 1) Classic Plus 14 or Classic Plus26 MovinCool Unit (1)
- 2) Cool Air Outlet Ducts (2)
- 3) Screws (8)
- 4) Operation Manual/Product Registration (1)

*NOTE: If any of these items were not included in the box or appear damage, please contact your MovinCool reseller for replacement.*

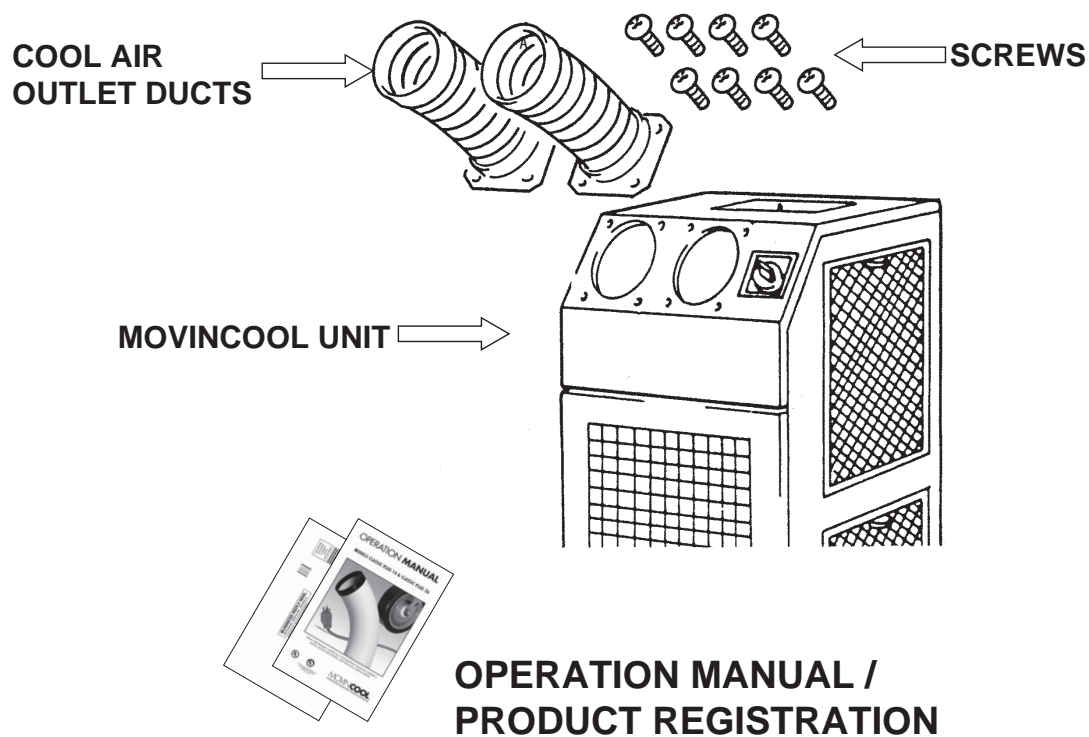

# INVENTORY & ASSEMBLY (cont.)

## Assembly

**⚠ CAUTION:** Before assembling make sure the unit is on a flat, level surface and the casters are in the **LOCKED** position. (Both the Classic Plus 14 and Classic Plus 26 MovinCool units have locking swivel casters in the front only.)

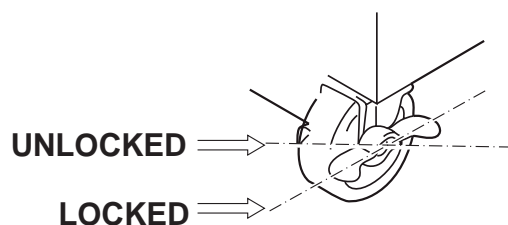

**Install each cool air outlet duct using 4 screws each as shown.**

*NOTE: Do not over tighten the screws when installing the cool air outlet ducts. This could damage the base on the cool air outlet duct assembly.*

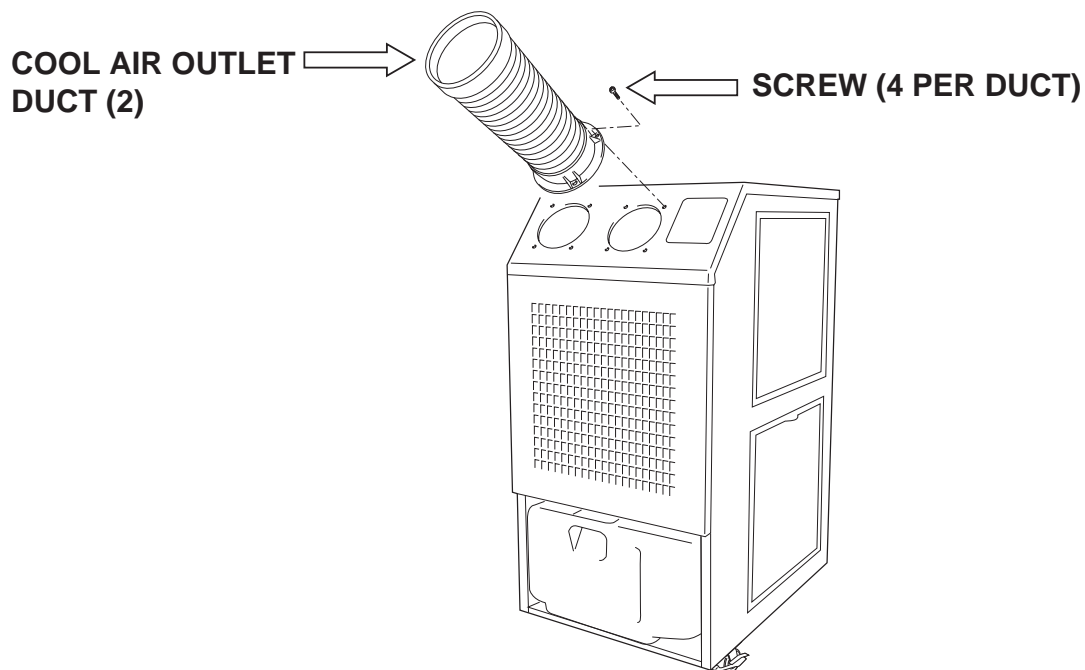



# INSTALLATION

## Choosing an Installation Site

**⚠ CAUTION: Following are some precautions to consider before choosing your installation site. Please review carefully as improper installation may result in personal injury or damage to the unit.**

- 1) Do not use the unit in areas where leakage of flammable gas may occur.
- 2) Do not use the unit in areas where it will be exposed to rain or water.
- 3) Do not use the unit in an atmosphere of excessively corrosive gas or vapor.
- 4) Do not use in areas where the temperature is outside the allowable operating range.
- 5) Do not install the unit in sloping areas. The unit may move or topple over even if the casters are set to the LOCKED position.
- 6) Install the unit in areas that can with-stand the weight of the unit. The Classic Plus 14 unit weighs approximately 200 lbs (91kg), and the Classic Plus 26 unit weighs approximately 280 lbs (127 kg) (when the drain tank is full of water).
- 7) Allow 18 inches of unobstructed airflow for both the air inlets and outlets.
- 8) Do not use the unit at condition above 113°F 50%RH.

# INSTALLATION (cont.)

## Moving the Unit

Unlock the casters and push the MovinCool unit using the side handles to a flat level surface and set the casters back to the LOCKED position.

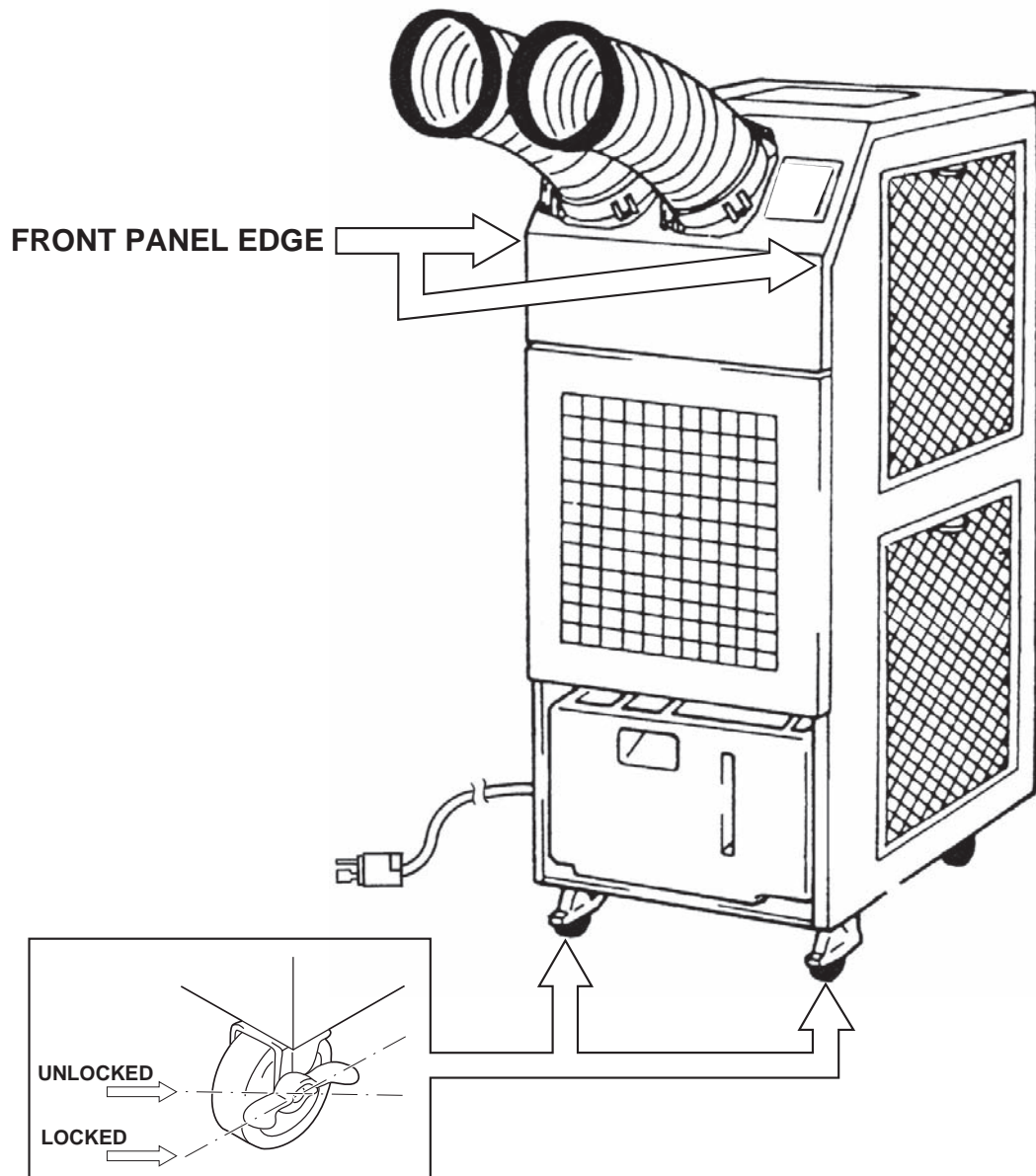

# INSTALLATION (cont.)

## Plugging in the Unit

- 1) Check the prongs and surface of the power cord plug for dust/dirt. If dust and/or dirt are present, wipe off with a clean, dry cloth.
- 2) Check the power cord, plug and prongs for damage or excess play. If any damage or excess play is found, contact your MovinCool reseller for repair.

### **WARNING:**

- 1) If the power cord or plug is damaged, repair should only be performed by qualified electrical personnel.
- 2) Do not connect/disconnect the power cord or attempt to operate buttons with wet hands. This could result in electrical shock.

### **CAUTION:**

- 1) **Classic Plus 14 model ONLY** : The AC outlet (115 VAC Single Phase, 60Hz) needs to be rated at 15A or higher. Do not share the outlet with any other instrument or equipment.
- 2) **Classic Plus 26 model ONLY** : The AC outlet (208/230 VAC Single Phase, 60Hz) needs to be rated at 20A or higher. Do not share the outlet with any other instrument or equipment.

### *NOTE:*

- 1) *Make sure the AC outlet is free of dirt, dust, oil, water, or any other foreign matter.*
- 2) *The Classic Plus 14 model is equipped with a UL approved LCDI cord and an approved NEMA plug configuration (5-15). The appropriate outlet must be used for this plug type.*
- 3) *The Classic Plus 26 model is equipped with a UL approved LCDI cord and an approved NEMA plug configuration (6-20). The appropriate outlet must be used for this plug type.*

# INSTALLATION (cont.)

## LCDI Power Cord Instruction

### WARNING

The LCDI device is non-serviceable device. Attempting to open the device may expose the user to hazardous of electric shock, and could void warranties of this product. Manufacturer's reliability is limited to the replacement of the device.

### CAUTION

1. Read the attention print on the device for proper use and handling of this device.
2. This device is used for monitoring leakage current.
3. Do not immerse in water.
4. This device must only be plugged into an appropriate wall outlet. Do not use on extension cords or adapter. Do not remove ground prong.
5. In the event that this device trips, the cause of malfunction should be corrected first before further use.
6. Using the device beyond recommended voltage poses risk to users.
7. Conductors inside this cord are surrounded by shields, which monitor leakage current. These shields are not grounded, and they are periodically examined the cord for any damage. Do not use this product in the event the shields become exposed.
8. Do not push test and/or reset buttons in a short period.

## PROCEDURE

Test device once when AC is installed to assure proper operation.

1. Plug into grounded power receptacle.
2. If light is not on, press reset button once. Light should turn on.
3. Press test button once, light must turn off.
4. Press reset button once again for use. Light should turn on.
5. If test fails, do not use.

### <FRONT VIEW>

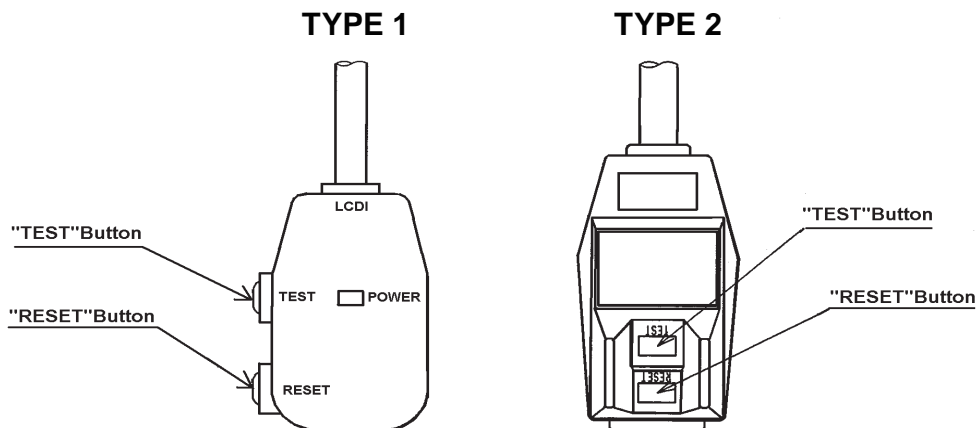

# FEATURES

For all models:

- 1) A digital electronic control panel, which allows the user to control the unit's operation easily.
- 2) Dual fan speeds (either HIGH or LOW) in both COOL and Fan Only modes.
- 3) Digital LCD display with blue backlight that indicates :
  - a. Clock with day and time.
  - b. Room Temperature and Set Point Temperature (either Fahrenheit or Celsius).
  - c. Fan Speed Status
  - d. Cool Mode Status
  - e. Program Start time and Stop time
  - f. Program Run and Stop
  - g. Status Codes
  - h. Key Locked option
- 4) The Set point Temperature can be adjusted between 70°F and 95°F by the SET TEMP buttons ( $\Delta$  /  $\nabla$ ).
- 5) A condensate drain TANK FULL indicator (LED) and display (LCD).
- 6) An automatic restart feature when the power is lost and regained. The unit will return to the operating mode it was in prior to the loss of power. Any preset program will be retained in the memory in the event power loss occurs.
- 7) A programmable Clock/Timer function. This allows the user to program a specific time and day that the unit will begin to operate/start and turn off/end (Automatic Operation).

# OPERATION

## Control Panel

Before operating the unit, it is important to familiarize yourself with the basic controls located on the control panel.

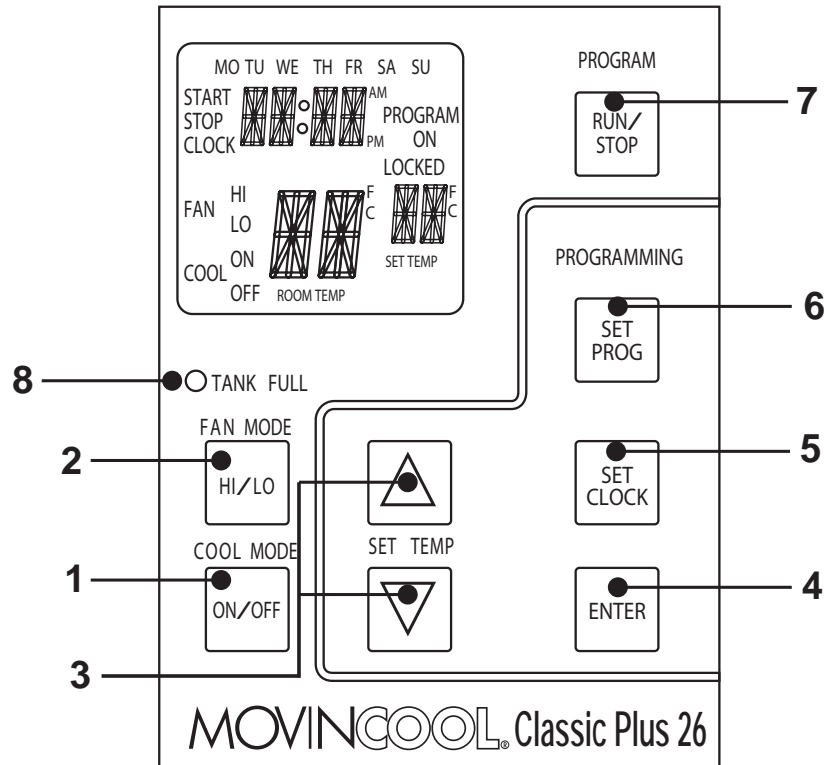

- 1) COOL Mode Button      Activates/deactivates the COOL mode/turns the unit off.
- 2) FAN Mode Button      Activates/deactivates the HIGH, LOW, and OFF fan speed.
- 3) SET TEMP Button (  $\Delta$  /  $\nabla$  )      Temperature Scale Illuminates to indicate the current LED temperatures being displayed are either in °C or °F ; also displays the clock when programming.
- 4) ENTER Button      Press to select set up value
- 5) SET CLOCK Button      To set clock (day and time)
- 6) SET PROG Button      To set or view program
- 7) RUN/STOP Button      Activates/deactivates program(s)
- 8) TANK FULL LED      Flashes when the drain tank is full.

# OPERATION (cont.)

## Control Panel (Cont.)

### LCD Indicators

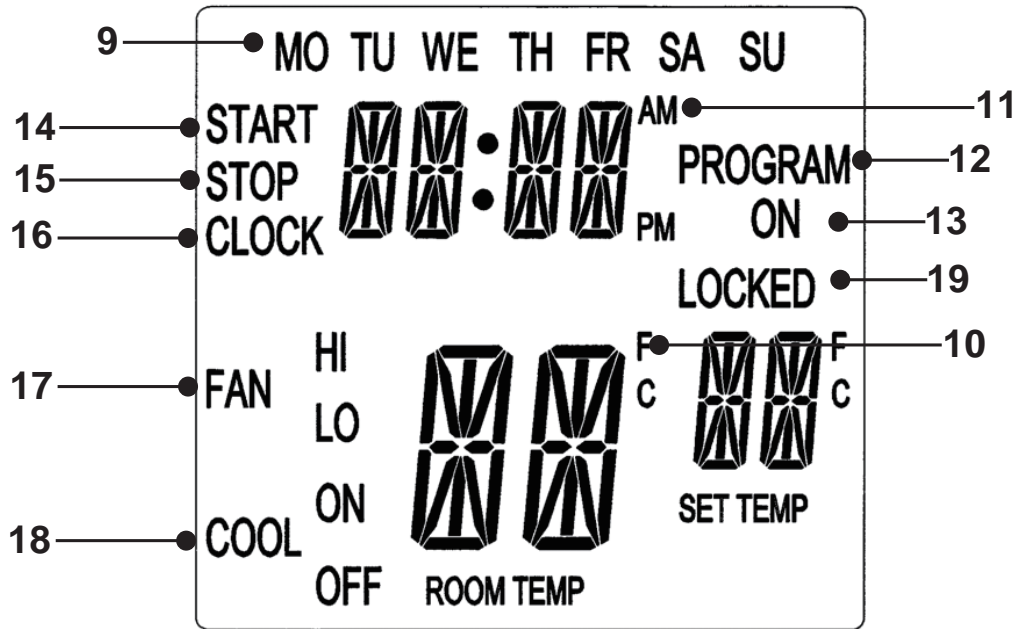

- |                 |  |
|-----------------|--|
| 9) MO...SU      | Illuminates to indicate selected day of the week                 |
| 10) °C or °F    | Temperature displayed in either Fahrenheit or Celsius (See Note) |
| 11) AM/PM       | Illuminates to indicate AM or PM time of day.                    |
| 12) PROGRAM     | Blinking during program editing mode.                            |
| 13) PROGRAM ON  | Illuminates to indicate program is running.                      |
| 14) START       | Illuminates to indicate program start time.                      |
| 15) STOP        | Illuminates to indicate program stop time.                       |
| 16) CLOCK       | Illuminates to indicate clock status.                            |
| 17) FAN HI/LO   | Illuminates to indicate selected fan speed.                      |
| 18) COOL ON/OFF | Illuminates to indicate cool on or off.                          |
| 19) LOCKED      | Illuminates to indicate key lock up.                             |

*NOTE: ROOM TEMP display range from 16°F to 109°F (-9°C to 42°C) In Fahrenheit only, when display values is greater than 99°F, it will display values of +0F (for 100°F), +1F (for 101°F) and +9F (for 109°F)*

# OPERATION (cont.)

## Set Clock

Prior to operating the Classic Plus 14 or Classic Plus 26 users should set the clock of the controller to the correct time as shown in the following steps:

- 1) Press and hold the SET CLOCK button for 3 seconds or until beep. (LCD will indicate blinking "CLOCK" and blinking "Day of the week")
- 2) Press SET TEMP buttons to select day of the week.
- 3) Press ENTER button to set Hour.
- 4) Press SET TEMP buttons to select desired hour.
- 5) Press ENTER button to set Minute.
- 6) Press SET TEMP buttons to select desired minute. Press SET CLOCK button to exit set clock mode.

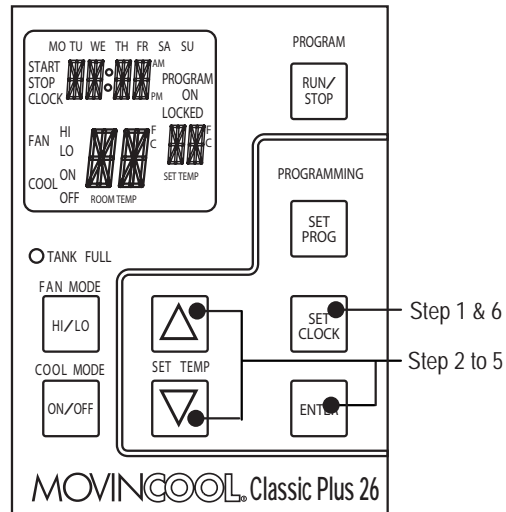

*Note: User should check clock periodically to confirm clock accuracy.*

## Operating in COOL Mode

- 1) The unit can be operated in COOL mode by pressing the COOL ON/OFF button (LCD indicates COOL ON).

*NOTE: In COOL mode the unit can only be turned off by pressing the COOL ON/OFF button again, not by pressing the fan buttons.*

- 2) Change the fan speed by pressing the fan HI/LO button.
- 3) Change the temperature set point by pressing the SET TEMP buttons ( $\Delta$  /  $\nabla$ ).

*NOTE: When turning the unit on, the set point and fan speed are determined by the last operating mode. (program mode not included)*

## Operating in Fan Only Mode

- 1) The unit can also be operated in Fan Only mode by pressing fan HI/LO button (LCD indicates FAN HI/LO and COOL OFF).
- 2) The unit can then be turned off by pressing the fan HI/LO button until fan turn off (Fan only mode speed sequence are HI→LO→OFF)

## Changing from Fan Only Mode to COOL Mode

The COOL mode can be activated while the unit is operating in Fan Only mode. To do this, simply press the COOL ON/OFF button (LCD indicates COOL ON).

*NOTE: The Fan Only mode will not operate after the COOL mode has been activated. After the COOL mode has been activated, the unit cannot be turned off by pressing the fan buttons. The COOL ON/OFF button must be pressed.*



# OPERATION (cont.)

## How to Set a Program

### SET START TIME

- 1) Press and hold the “SET PROG” button for 3 seconds or until beep.
- 2) Press “SET TEMP” buttons to select day of the week.
- 3) Press “ENTER” button.
- 4) Press “SET TEMP” buttons to select desired hour.
- 5) Press “ENTER” button.
- 6) Press “SET TEMP” buttons to select desired minute.
- 7) Press “ENTER” button.

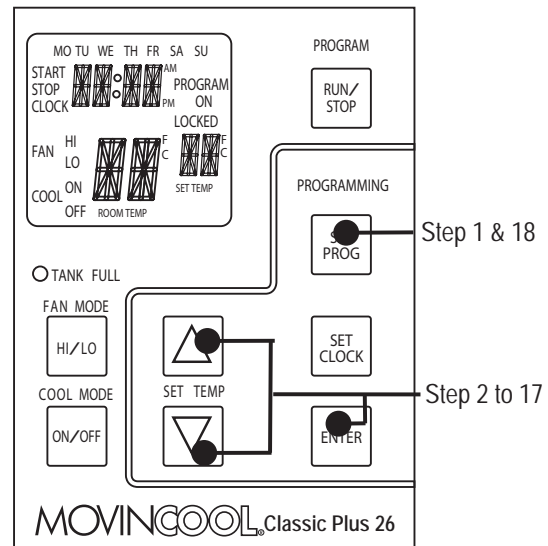

### SET STOP TIME

- 8) Press “SET TEMP” buttons to select day of the week.
- 9) Press “ENTER” button.
- 10) Press “SET TEMP” buttons to select desired hour.
- 11) Press “ENTER” button.
- 12) Press “SET TEMP” buttons to select desired minute.
- 13) Press “ENTER” button.

### SET FAN SPEED

- 14) Press “SET TEMP” buttons to select desired fan speed.
- 15) Press “ENTER” button.

### SET SET-POINT TEMPERATURE

- 16) Press “SET TEMP” buttons to select desired temperature.
- 17) Press “ENTER” button.

### EXIT PROGRAM EDITING MODE

- 18) Press “SET PROG” button to exit program editing mode.

### EDIT MULTIPLE PROGRAMS

- 19) Repeat step 1) to 18) to set up multiple programs.

*NOTE: Maximum 7 programming sequences*

# OPERATION (cont.)

## How to View and Delete Program

- 1) Press and hold the SET PROG button for 3 seconds or until beep.
- 2) To view edited program - While pressing and holding the SET PROG button, press SET TEMP (  $\triangle$  /  $\nabla$  ) to scroll the program sequence.
- 3) To delete a program - Press ENTER and SET PROG buttons once simultaneously.
- 4) To delete multiple program - Press and hold ENTER and SET PROG buttons simultaneously.

## How to Run and Stop Program

- 1) Press RUN/STOP button to activate preset program (LCD indicates PROGRAM ON). During RUN program, if user push RESET program run will be terminated, to resume RUN program user must push RUN/STOP button again.
- 2) Press RUN/STOP button to stop program.

### NOTE:

- 1) *The unit will return to the previous mode if a program is turned off while it is running.*
- 2) *The LCD continues to indicate PROGRAM ON during program activating.*
- 3) *Program can be set during power on standby, during unit running, or during program running.*
- 4) *During programming, the unit returns to the previous mode if no activity occurs within approximately 3 minutes.*

# OPERATION (cont.)

## Operating Modes

The Classic Plus 14 and Classic Plus 26 can be operated in two modes, Fan Only and COOL. When in Fan Only mode, the unit circulates the surrounding air. When in COOL mode, the compressor is operational and cool air is circulated.

### 1) COOL Mode

Once the compressor has been disengaged for more than 120 seconds, the unit will operate in Fan Only mode for approximately 5 seconds before the compressor re-engages. (Time delay setting is around 120 seconds).

### 2) Temperature Control

The room temperature thermistor monitors the inlet temperature versus SET POINT temperature and switches the unit automatically between COOL and Fan Only modes.

### 3) Fan Mode Control DIP Switch

The Fan Mode Control DIP Switch determines whether the FAN will continue to operate or stop when the compressor cycles off. (SET POINT temperature equals inlet air or room temperature.) The unit has been preset at the factory for continuous fan operation.

### 4) Temperature Scale Display DIP Switch

The Temperature Scale Display DIP Switch changes the temperature(s) that are displayed to either °C or °F. The unit has been preset from the factory to display the temperature(s) in °F.

*NOTE: If you wish to change the fan mode operation (COOL\_OPERATE to COOL\_STOP), and/or the Temperature Scale Display (°F to °C), contact your MovinCool reseller.*

# OPERATION (cont.)

## Self-Diagnostic Codes

**Self-Diagnostic Codes will be displayed on the Control Board under the following conditions:**

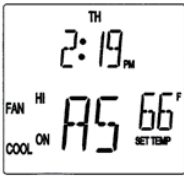
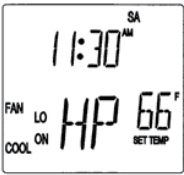
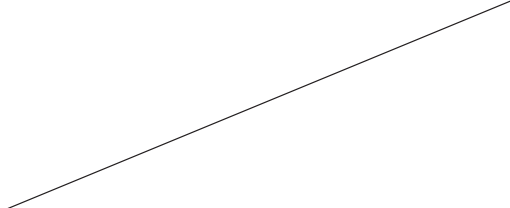
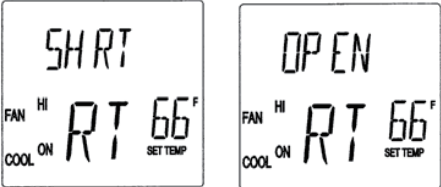
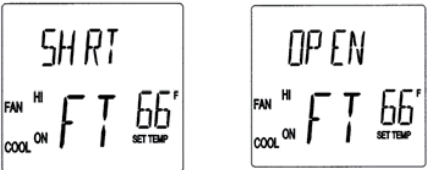
LCD Display Codes	Condition
	<p>When the drain tank switch shuts off the unit LCD displays “TANK FL” and FULL TANK LED flashes. Once emptying the drain tank procedure is completed and “ON/OFF” has been pushed, unit will return to normal operation.</p>
	<p>When the drain pump malfunctions, the compressor will shut off, and LCD will display “AS”. Once drain pump is fixed and unit has been RESET, the unit will return to normal operation. Contact your MovinCool reseller if problem persists.</p>
	<p>&lt; Classic Plus 26 ONLY &gt; When high pressure switch is activated, display will show “HP” if high pressure switch is activated 3 times in 24 hours, unit will display blinking “HP” and buzzer sound will be on. Unit will return to normal operation after problem is fixed and controller is RESET (See page 26 troubleshooting section). Contact your MovinCool reseller if problem persists.</p>
	<p>To RESET press FAN HI/LO and COOL ON/OFF buttons simultaneously for 3 seconds, controller will return to normal operation.</p>
	<p>When room thermistor becomes open or shorted, display will show “OPEN RT” or “SHRT RT” and cool mode operation will be off. Display and cool mode operation will be resumed to normal operation after room thermistor is fixed. Contact your MovinCool reseller if problem persists.</p>
	<p>When freeze thermistor becomes open or shorted, display will show “OPEN FT” or “SHRT FT” and cool mode operation will be off. Display and cool mode operation will be resumed to normal operation after freeze thermistor is fixed. Contact your MovinCool reseller if problem persists.</p>

## OPERATION (cont.)

### Empty the Drain Tank

During COOL mode, condensate will accumulate in the drain tank. When the drain tank becomes full, the FULL TANK LED will flash and the LCD displays "Tank FL" and the unit will shut off automatically.

*NOTE: If you want to empty the drain tank, while the unit is in operation, press the COOL ON/OFF button to turn the unit off. If a program is running, you must first press the Program RUN button.*

**1) Pull the drain tank from the unit.**

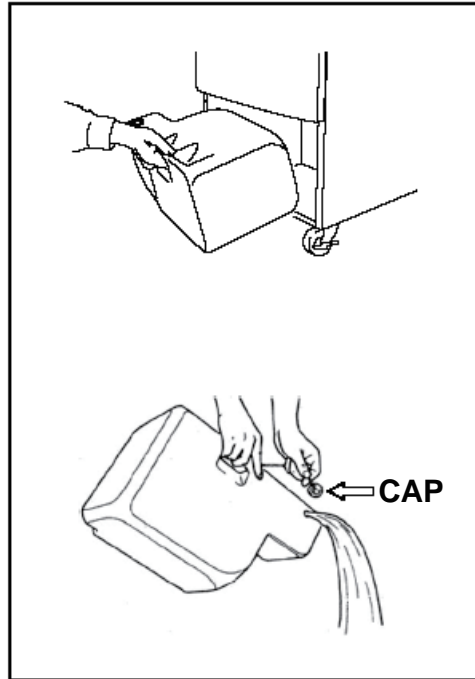

**2) Remove the cap and empty the drain tank.**

**3) Replace the cap and return the drain tank to the unit.**

**4) Press the COOL ON/OFF or FAN ON/OFF button to restart the unit.**

**5) If the LCD indicates Program ON, press the COOL ON/OFF button to continue running the program. If the LCD indicates Program ON is illuminated continuously, no further steps are necessary. If no program exists or the program was deactivated, press the COOL ON/OFF button to restart the unit.**

## OPERATION (cont.)

### Drain Pump Kit (Optional) (Classic Plus 14 model ONLY)

A drain pump kit is available to allow continuous operation and to eliminate the need for a drain tank.

When the water collects to level (A) in the pump reservoir, the drain pump begins to operate and discharge the water.

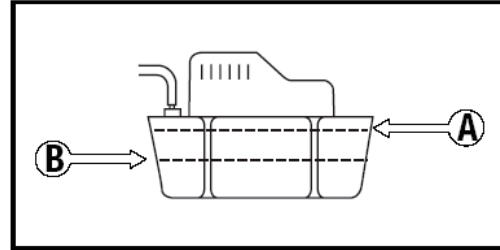

*NOTE: The compressor will not operate while the drain pump is discharging water.*

When the water level drops below level (B), the drain pump stops, and the compressor will restart.

*NOTE: If for any reason the water level exceeds that of level (A) in the pump reservoir, an over flow Drain Switch will stop the compressor operation.*

*NOTE: If the Fan Mode Control DIP Switch (see pg.19) is set to the STOP position, the entire unit (including fan operation) will turn off whether due to the over flow Drain Switch or while the drain pump is discharging water.*

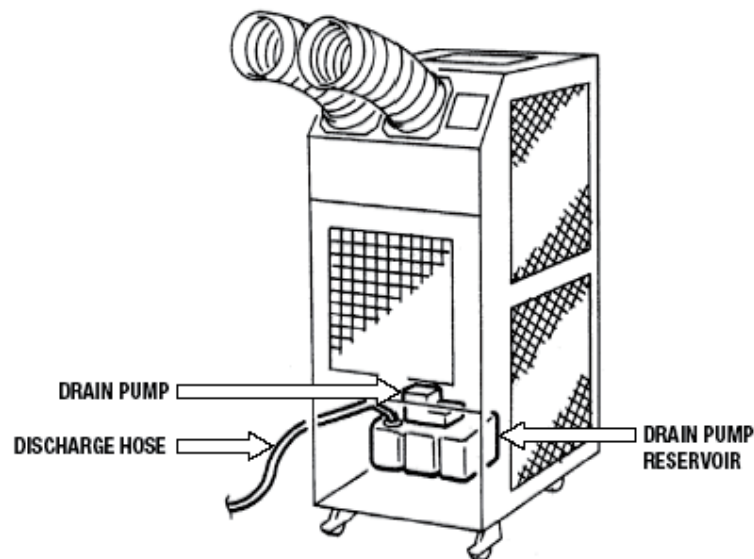

## OPERATION (cont.)

### Drain Pump Kit (Optional) (Classic Plus 26 model ONLY)

A drain pump kit is available to allow continuous operation and to eliminate the need for a drain tank.

When the water collects to level (A) in the pump reservoir, the drain pump begins to operate and discharge the water.

When the water level drops below level (B), the drain pump stops, and the compressor will restart.

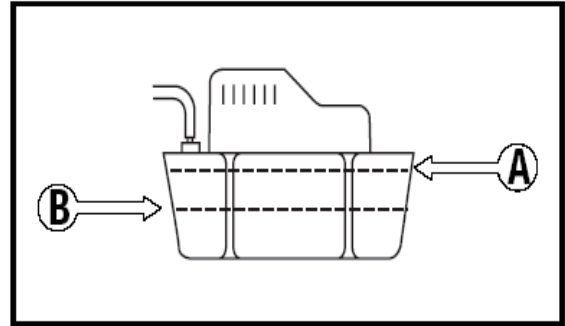

*NOTE: If for any reason the water level exceeds that of level (A) in the pump reservoir, an overflow Drain Switch will stop the compressor operation.*

*NOTE: If the Fan Mode Control DIP Switch (see pg. 19) is set to the STOP position, the entire unit (including fan operation) will turn off due to the over flow Drain Switch.*

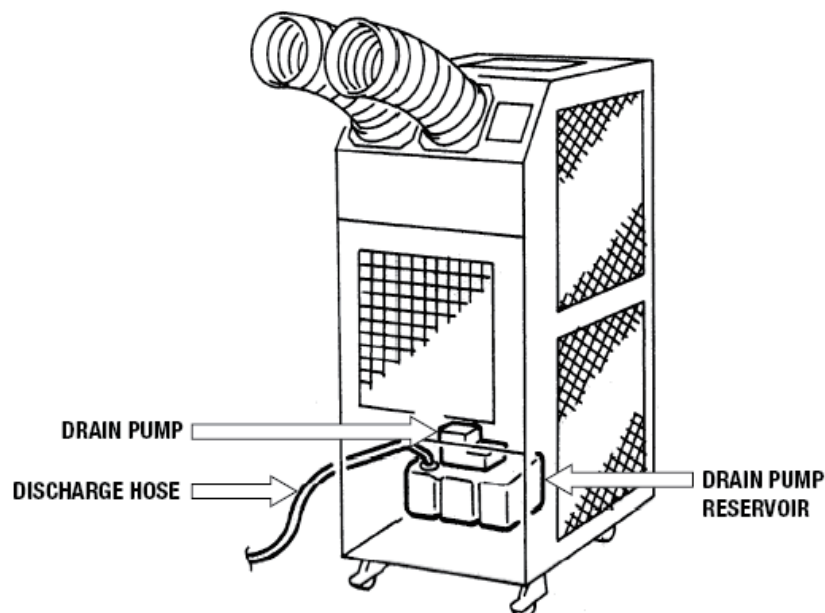

# DAILY INSPECTION & MAINTENANCE

## Empty the Drain Tank

To empty the drain tank, refer to instructions on page 21.

## Clean the Air Filters

Clean the air filters once a week. If the unit is used in a dusty environment, more frequent cleaning may be required.

A dirty air filter can reduce air output resulting in a decrease in cooling capacity.

### Filter Removal Method (both models)

- 1) Turn the unit off, by pressing the **COOL ON/OFF** button.
- 2) Remove the three air filters.

*NOTE : To remove the side air filters, lift upward, then pull outward from the bottom. To remove the front panel air filter, pull out top corners, then lift upward.*

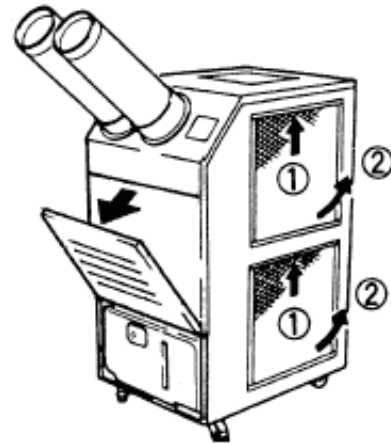

- 3) Remove the element from each filter.

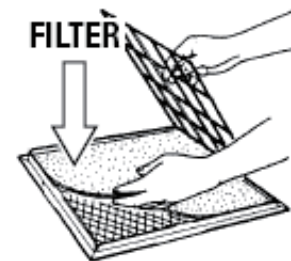

### Filter Element Cleaning Method (both models)

- 1) Remove dust from the element with a vacuum cleaner, or rinse in cold or lukewarm water. If the element is extremely dirty, wash with a neutral detergent.
- 2) After the element has been cleaned, rinse with clean running water, allow to dry, then reinstall.

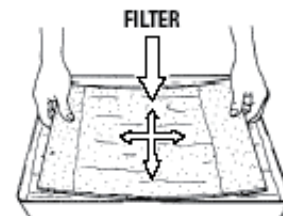



# **DAILY INSPECTION & MAINTENANCE (cont.)**

## **In-Season/Off-Season Inspection & Maintenance**

### ***In-Season***

- 1) Check the prongs and surface of the power cord plug for dust and/or dirt. If dust and/or dirt are present, wipe off with a clean dry cloth.**
- 2) Check the power cord, plug and prongs for damage or excess play . If any damage or excess play is found, contact your MovinCool reseller for repair.**
- 3) Check the air filters and drain tank.**
- 4) Clean the outside of the unit(s) with a damp cloth or mild nonabrasive cleaner.**

### ***Off-Season***

- 1) Operate the unit in Fan Only mode for 8 hours.**  
*NOTE : Operation is necessary to dry out the inside of the unit.*
- 2) Disconnect the power cord from the AC outlet.**
- 3) Check the prongs and surface of the power cord plug for dust and/or dirt. If dust and/or dirt are present, wipe off with a clean dry cloth.**
- 4) Check the power cord, plug and prongs for damage or excess play. If any damage or excess play is found, contact your MovinCool reseller for repair.**
- 5) Clean the air filters.**
- 6) Empty all water from the drain tank.**

# TROUBLESHOOTING

Check the following items before calling a qualified technician

<b>SYMPTOM</b>	<b>POSSIBLE CAUSE</b>	<b>REMEDY</b>
Unit does not operate	1) Ground fault breaker trip or LCDI power cord trip.	Reset Breaker or Reset power cold.
	2) Drain Tank is full (Tank Full LED will be flashing)	Empty the drain tank
	3) High Pressure Activated 10 times in 24hours.	1) Clean air filter. 2) Check inlet and outlet air, and make sure that there were not any object that may prevent air flow into or out from the unit. 3) Check environmental condition whether it is within operation range or not. 4) Reset controller.
Insufficient Cooling	1) Dirty/Blocked air filters	Clean air filter
	2) Air Inlet/Outlet blocked	Clean air inlet/outlet
	3) Improper temperature setting	Adjust temperature setting

If symptoms persist after the above actions have been taken, turn the unit off, disconnect the power cord plug and contact your MovinCool reseller.

# TECHNICAL SPECIFICATONS

ITEMS/FEATURES	Classic Plus 14	Classic Plus 26
<b>Rating Conditions</b> Dry bulb Wet bulb Humidity	95°F(35°C) 83°F(28.2°C) (60%)	95°F(35°C) 83°F(28.2°C) (60%)
<b>Specifications</b> Power frequency Line voltage Power consumption Current consumption Power factor Starting current Power wiring	60Hz Single phase 115V 1.41kw 12.3Amps 95% 32A 14(3-core)AWG	60Hz Single phase 208/230V 3.37/3.24kw 16.8/14.6Amps 97% 62A 12(3-core)AWG
<b>Cooling Unit</b> Cooling capability  Cooling system	3,300kcal/hr 13,200Btu/hr Direct Expansion	6,500kcal/hr 26,000Btu/hr Direct Expansion
<b>Blower</b> Type of fan Air volume:Evaporator (High speed) Condenser (High speed) Motor output (High) (Low)	Centrifugal Fan 470ft <sup>3</sup> /min(798m <sup>3</sup> /h) 882ft <sup>3</sup> /min(1498m <sup>3</sup> /h) 0.24kw 0.19kw	Centrifugal Fan 708ft <sup>3</sup> /min(1202m <sup>3</sup> /h) 1680ft <sup>3</sup> /min(2853m <sup>3</sup> /h) 0.59/0.63kw 0.54/0.56kw
<b>Compressor</b> Type Output Refrigerant Type Refrigerant Capacity	Hermetic Rotary 0.8kw R-22 1.50lbs(0.68kg)	Hermetic Scroll 1.6kw R-22 1.87lbs(0.85kg)
<b>Safety Devices</b> Compressor overload protector Fan motor protector Anti-freezing thermistor Full drain tank switch Automatic Restart (power interruption) Compressor time delay program High Pressure Interruption Signal Input/Output	Include Include Include Include Include Include N/A N/A	Include Include Include Include Include Include Include N/A
<b>Dimensions &amp; Weight</b> WxDxH (in) WxDxH (mm) Weight (lbs/kg)	19.4"×26.5"×41.5" 492×673×1054 165/75	19.4"×28.7"×47.2" 492×730×1200 235/107
<b>Operating Conditions</b> Inlet air (Relative humidity)	113°F(45°C) ≤ 50% 70°F(21.1°C) ≥ 50%	113°F(45°C) ≤ 50% 70°F(21.1°C) ≥ 50%
<b>Control Device</b> Temperature Control Programmable Timer Two Speed Fan	Include Include Include	Include Include Include



# LIMITED WARRANTY

DENSO SALES CALIFORNIA, INC. (“DENSO”) warrants its MOVINCOOL Products only to the extent stated in its official written warranties. Unless otherwise specifically provided in writing by DENSO, DENSO warrants to end-user that the Products shall be free of defects in materials or workmanship and will function in accordance with DENSO’s published specifications under ordinary intended use and service for a period of twelve (12) months after delivery to the end-user ; provided, however in the case of the compressor element of the Products such warranty shall be for a period of thirty six (36) months after delivery to the end-user. DENSO shall, at its sole option, repair or replace any defective Product covered by this warranty. Such remedy shall be end-user’s sole remedy with respect to any particular defect in the Products.

This warranty does not cover defects or malfunctions which result from causes beyond DENSO’s control, including, without limitation, ( i ) unusual physical or electrical stress ; ( ii ) accident, neglect, abuse, misuse or other abnormal use ; (iii) failure to perform routine maintenance in accordance with DENSO’s recommended procedures ; ( iv ) normal wear and tear ; ( v ) repairs or attempted repairs by an unauthorized person ; (vi) modifications or alterations to the Products ; (vii) use with supplies or devices not supplied or approved by DENSO ; or (viii) improper servicing. This warranty shall extend only to the original end-user and shall be void if any labels or other identifying marks permanently affixed to Products when shipped by DENSO are removed, altered, defaced or obliterated.

The aforesaid warranty is the only warranty made by DENSO with respect to the Products and is in lieu of all obligations or liabilities on the part of DENSO for damages arising out of or in connection with the sale, use or performance of the Products, including, without limitation, any lost profits or any other consequential, incidental, special or exemplary damages of any kind. DENSO DISCLAIMS ALL OTHER WARRANTIES WITH REGARD TO THE PRODUCTS, INCLUDING ALL IMPLIED WARRANTIES OF MERCHANTABILITY AND FITNESS FOR USE. THERE ARE NO WARRANTIES WHICH EXTEND BEYOND THE DESCRIPTION CONTAINED HEREIN.

**PURCHASE DATE :** \_\_\_\_\_

**SERIAL NUMBER :** \_\_\_\_\_

# ***DENSO***

**DENSO SALES CALIFORNIA, INC.**

**3900 Via Oro Avenue  
Long Beach CA 90810-1868  
800-264-9573 / 310-834-6352  
[www.movincool.com](http://www.movincool.com)**